

RVH8596

UNDERMOUNT SLOPE BOTTOM SINK

RUVATI[®]
SPECIFICATION SHEET

MATERIAL

True 16 Gauge Thickness
Premium T304 Grade Stainless Steel
18/10 Chromium/Nickel Content
Commercial Brushed Finish



FEATURES

- Heavy duty sound guard padding and undercoating
- Slanted bottom with elegant drain grooves for easy draining
- Reversible Offset Drain with Sloped Bottom



IN THE BOX



Basket Strainer
[RVA1025]

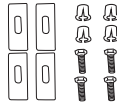

Mounting Clips
[RVA11031]

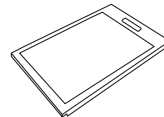

Cutting Board
[RVA1217]

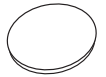

Drain Cover
[RVA1035]



Cut-out
Template

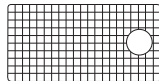

Rinse Grid
[RVA68596]

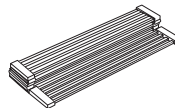

Folding Rack
[RVA1395]

NOMINAL DIMENSIONS

Exterior: 36" (wide) x 19" (front-to-back)
Interior Bowl: 34-1/2" (wide) x 16" (front-to-back)
Bowl Depth: 10"
Minimum Cabinet Size: 39" wide
Drain Hole Size: 3 1/2"

Installation Type:
Undermount
Inside Corners:
Rounded
Drain Location:
Offset

RUVATI USA

www.ruvati.com

Phone: 1.855.478.8284
Email: support@ruvati.com

OPTIONAL ACCESSORIES (SOLD SEPARATELY)



Deep Basket
Disposal Flange
[RVA1049ST]

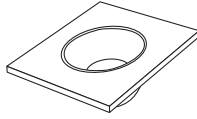

Mixing Bowl
and Platform
[RVA1288]

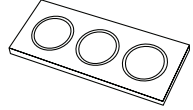

Condiment
Serving Tray
[RVA1377]

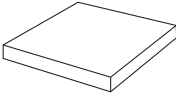

Butcher Block
[RVA2445ACA]

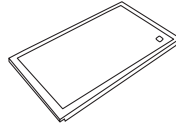

Black Plastic
Cutting Board
[RVA1217BLK]

DIMENSIONS

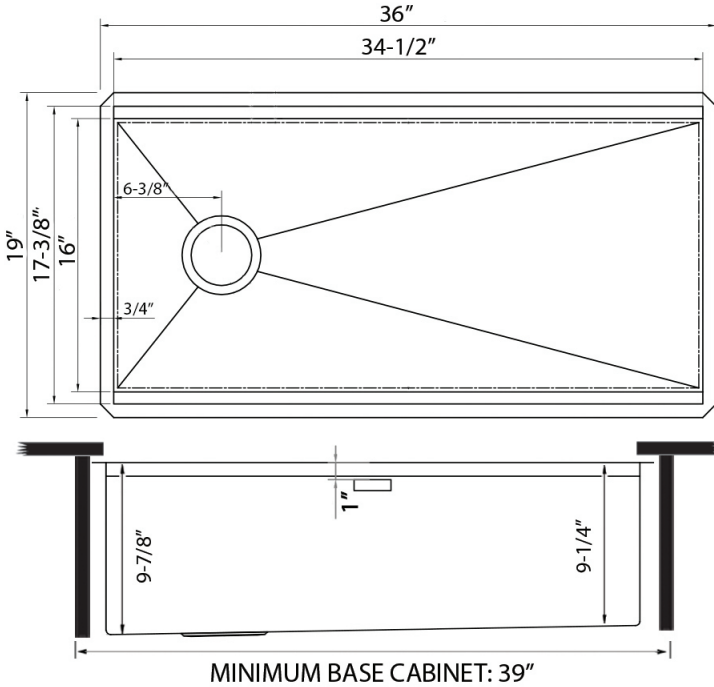

Register your product at www.ruvati.com/register.

RUVATI USA
www.ruvati.com

Phone: 1.855.478.8284
Email: support@ruvati.com