

RVU6124

UNDERMOUNT LAUNDRY SINK

MATERIAL

- True 16 Gauge Thickness
- Premium T304 Grade Stainless Steel
- 18/10 Chromium/Nickel Content
- Commercial Brushed Finish

FEATURES

- Heavy duty sound guard padding and undercoating
- Slanted bottom with elegant drain grooves for easy draining
- Extra deep sink for utility room

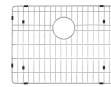

IN THE BOX



Basket Strainer
[RVA1025]

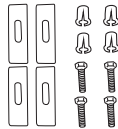

Mounting Clips
[RVA11031]

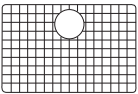

Rinse Grid
[RVA6124]



Cut-out
Template

NOMINAL DIMENSIONS

- Exterior:** 24" (wide) x 18" (front-to-back)
- Interior Bowl:** 22" (wide) x 16" (front-to-back)
- Bowl Depth:** 13"
- Minimum Cabinet Size:** 27" wide
- Drain Hole Size:** 3½"

- Installation Type:** Undermount
- Inside Corners:** Zero Radius
- Drain Location:** Rear Center

OPTIONAL ACCESSORIES (SOLD SEPARATELY)



Deep Basket
Disposal Flange
[RVA1049ST]



Drain Cover
[RVA1035]

DIMENSIONS

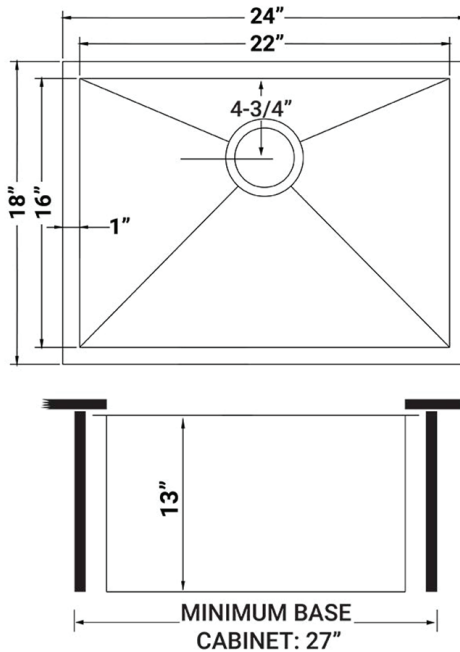

Register your product at www.ruvati.com/register.